

12 11 10 9 8 7 6 5 4 3 2 1625

J
I
H
G
F
E
D
C
B
A

J
I
H
G
F
E
D
C
B
A

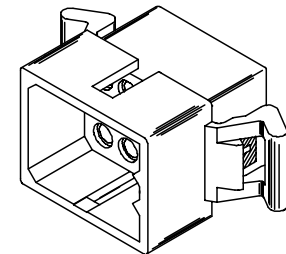
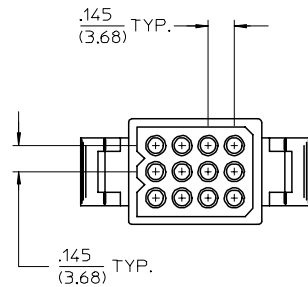
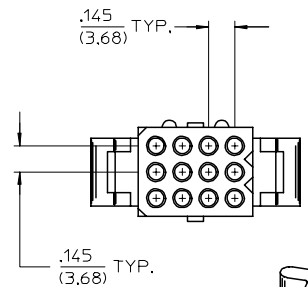
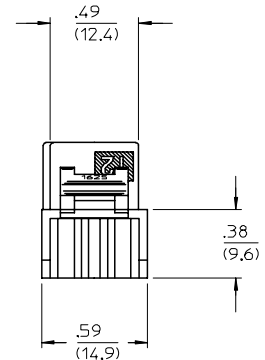
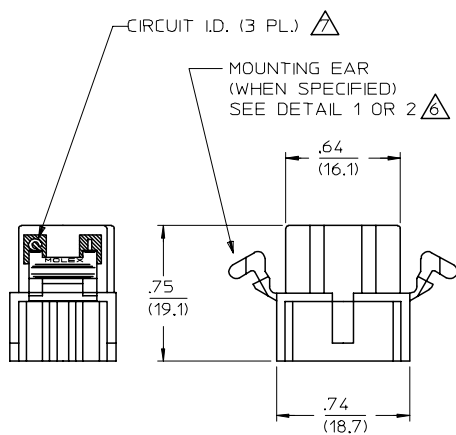
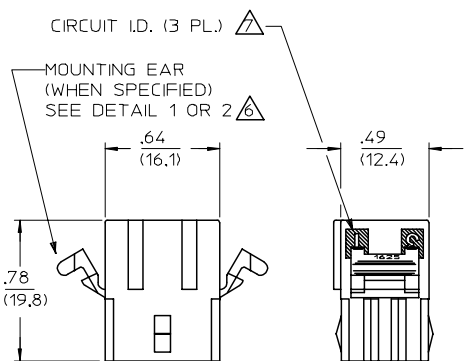
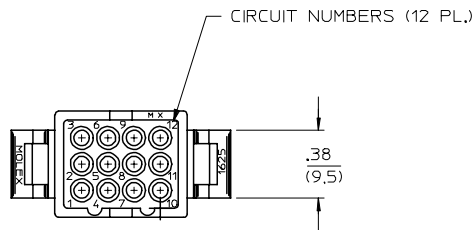
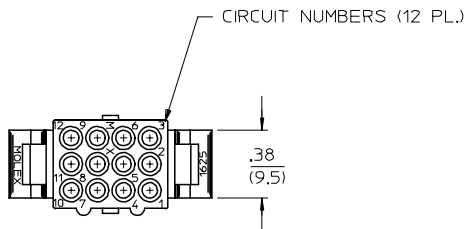

PLUG HOUSING (NOT TO SCALE)

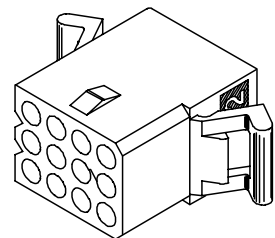

RECEPTACLE HOUSING (NOT TO SCALE)

TRANSLATED TO S.D. EC NO: UCP2004-2551 DRAWN:RHOLTS 2004/12/03 CHKD:FSMTH 2004/12/03 APPR:FSMTH 2004/12/06	DESCRIPTION	QUALITY SYMBOLS	GENERAL TOLERANCES (UNLESS SPECIFIED)		SCALE	DESIGN UNITS	THIRD ANGLE PROJECTION	REVISE ON CAD ONLY		
		▽-0	mm	INCH	1:1	INCH		TITLE		
		▽C-0	4 PLACES ± --- ± ---	3 PLACES ± --- ± .010	2 PLACES ± 0.25 ± .014	1 PLACE ± 0.36 ± ---	DIMENSION STYLE		.062/(1.57) HOUSINGS, PLUG & RECEPTACLE 12 CKT, 145 CENTERS	
			ANGULAR ± 1 °		DRAFT WHERE APPLICABLE		IN/MM		MOLEX INCORPORATED	
		MUST REMAIN WITHIN DIMENSIONS		DRAWN BY DATE GWC 1993/02/01		MATERIAL NO.		DOCUMENT NO.	SHEET NO.	
				CHECKED BY DATE RW 1993/02/01		SEE CHART		SD-1625-12*	1 OF 2	
				APPROVED BY DATE RAS 1993/02/01		THIS DRAWING CONTAINS INFORMATION THAT IS PROPRIETARY TO MOLEX INCORPORATED AND SHOULD NOT BE USED WITHOUT WRITTEN PERMISSION				

11 10 9 8 7 6 5 4 3 2 1

PLUG	
PART NO.	ENG. NO.
03-06-2121	1625-12P
03-06-7121	1625-12PBK
03-06-2122	1625-12P1
03-06-7122	1625-12P1BK

RECEPTACLE	
PART NO.	ENG. NO.
03-06-1121	1625-12R
03-06-6121	1625-12RBK
03-06-1122	1625-12R1
03-06-6122	1625-12R1BK
	OBSOLETE

RECEPTACLE LEGEND

1625-12R***
 CIRCUIT SIZE
 R = RECEPTACLE
 BLANK = WITH PREBENT MOUNTING EARS
 1 = WITHOUT EARS
 COLOR:
 BLANK = NATURAL COLOR
 AM = AMBER BK = BLACK BU = BLUE
 BN = BROWN GY = GRAY GN = GREEN
 OR = ORANGERD = RED YW = YELLOW

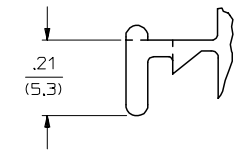

DETAIL 1
STANDARD MOUNTING EAR
SCALE 4:1

PLUG LEGEND

1625-12P***
 CIRCUIT SIZE
 P = PLUG
 BLANK = WITH PREBENT EARS
 1 = WITHOUT EARS
 COLOR:
 BLANK = NATURAL COLOR
 AM = AMBER BK = BLACK BU = BLUE
 BN = BROWN GY = GRAY GN = GREEN
 OR = ORANGE RD = RED YW = YELLOW

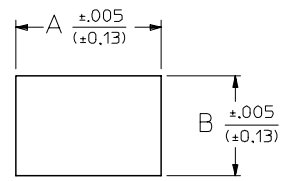
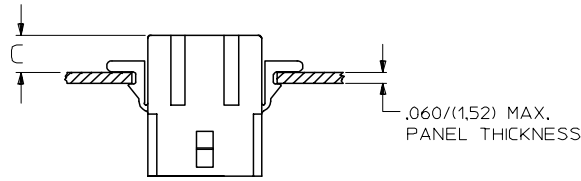

RECOMMENDED HOLE PATTERN

RECEP.	.795 (20.19)	.563 (14.30)		.23 (5.8)
PLUG	.903 (22.94)	.614 (15.60)	.21 (5.3)	.22 (5.5)
PART	DIM. A	DIM. B	DIM. C (STANDARD EAR)	DIM. C (PREBENT EAR)

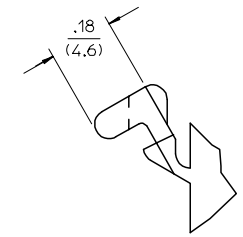
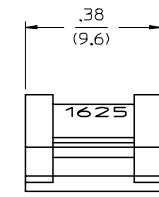

DETAIL 2
.062/(1.57) PREBENT MOUNTING EAR
SCALE 4:1

NOTES:

1. MATERIAL: NYLON TYPE 6/6, 94V-2.
 2. FINISH: NONE
 3. PRODUCT SPECIFICATION: PS-02-06
 4. PACKAGING INFORMATION: PK-1625-001
 5. THIS HOUSING FOR USE WITH .062/(1.57) DIA. TERMINALS.
- WHERE DENOTED IN CHART, TOOLS ARE BUILT WITH PREBENT MOUNTING EARS PER DETAIL 2 AND SUPERSEDE ALL TOOLS PREVIOUSLY BUILT WITH THE STANDARD MOUNTING EARS.
- CIRCUIT ID. NUMBERS APPEAR ON PARTS FROM TOOLS BUILT AFTER 2/1/93.

TRANSLATED TO SD. ELC NO: UCP2004-2551 DRAWN: RHOLTS 2004/12/03 CHKD: FSMTH 2004/12/03 APPR: F SMITH 2004/12/06	QUALITY SYMBOLS -0 -0	GENERAL TOLERANCES (UNLESS SPECIFIED) 4 PLACES ± --- ± --- 3 PLACES ± --- ± .010 2 PLACES ± 0.25 ± .014 1 PLACE ± 0.36 ± --- ANGULAR ± 1 °	SCALE 1:1 DESIGN UNITS INCH DIMENSION STYLE IN/MM	THIRD ANGLE PROJECTION REVISE ON CAD ONLY
	DRAFT WHERE APPLICABLE MUST REMAIN WITHIN DIMENSIONS	DRAWN BY DATE GWC 1993/02/01 CHECKED BY DATE RW 1993/02/01 APPROVED BY DATE RAS 1993/02/01	TITLE .062/(1.57) HOUSINGS, PLUG & RECEPTACLE 12 CKT, 145 CENTERS	MATERIAL NO. SEE CHART DOCUMENT NO. SD-1625-12* SHEET NO. 2 OF 2
	THIS DRAWING CONTAINS INFORMATION THAT IS PROPRIETARY TO MOLEX INCORPORATED AND SHOULD NOT BE USED WITHOUT WRITTEN PERMISSION			
	MOLEX INCORPORATED			