

13 12 11 10 9 8 7 6 5 4 3 2 1

J  
I  
H  
G  
F  
E  
D  
C  
B  
A

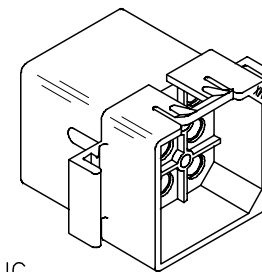
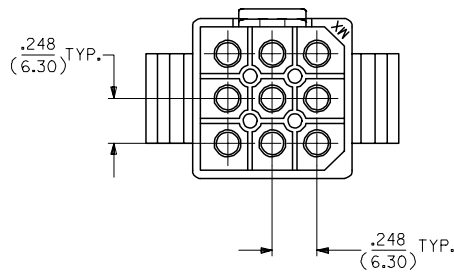
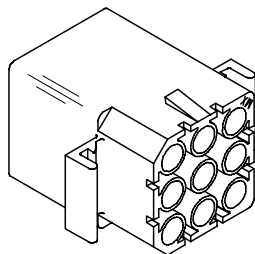
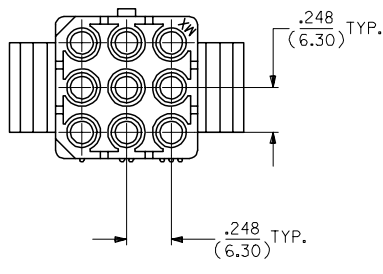
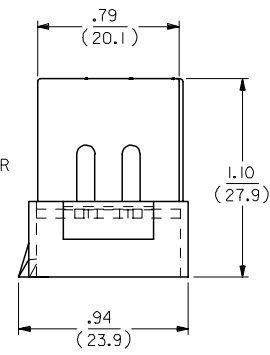
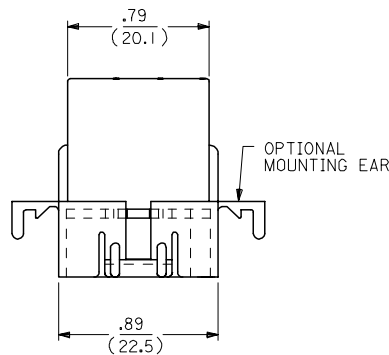
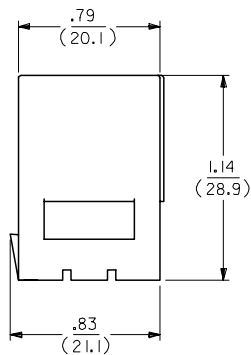
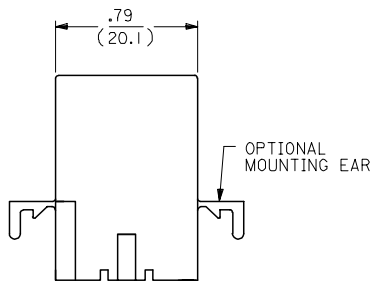
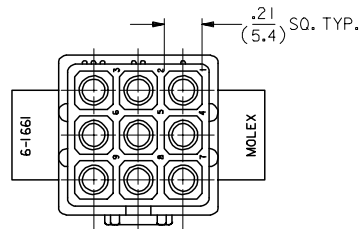
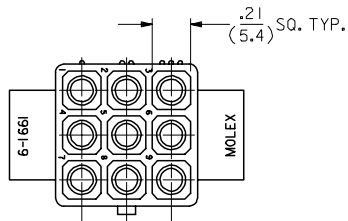

RECEPTACLE

PLUG

2	J
1	J
SHT. REV.	

<b>UPDATE TITLE BLOCK</b> EC NO: UCP2007-1498 DRW: AELHAG 2007/04/04 CHKD: AELHAG 2007/04/04 APPR: FSM TH 2007/04/04 REV DESCRIPTION	QUALITY SYMBOLS ▽=0 ▽=0	GENERAL TOLERANCES (UNLESS SPECIFIED) mm INCH 4 PLACES ± .10 ± .010 3 PLACES ± .125 ± .014 2 PLACES ± 0.25 ± .014 1 PLACE ± 0.35 ± .014 ANGULAR ± 1 °	DIMENSION STYLE IN/MM DRAWN BY DATE KBW 1989/04/25 CHECKED BY DATE RW 1989/04/25 APPROVED BY DATE RAS 1989/04/25 MATERIAL NO. DOCUMENT NO.	SCALE 2:1 DESIGN UNITS INCH THIRD ANGLE PROJECTION	TITLE .093/(2.36) HOUSINGS, PLUG AND RECEPTACLE, 9 CKT, .248/(6.30) CTRS. MOLEX INCORPORATED	SHEET NO. 1 OF 2
	DRAFT WHERE APPLICABLE MUST REMAIN WITHIN DIMENSIONS		SEE CHART	SD-1991-9*		THIS DRAWING CONTAINS INFORMATION THAT IS PROPRIETARY TO MOLEX INCORPORATED AND SHOULD NOT BE USED WITHOUT WRITTEN PERMISSION

12 11 10 9 8 7 6 5 4 3 2 1

